

**flusso.**  
POCKET DOOR SYSTEMS



**lpcd**  
DOORS

**EXPECT MORE**  
POCKET DOOR SYSTEMS

# Introducing **flusso.** by LPD Doors

Our amazing range of internal pocket door sets, kits and accessories. The range offers two types of internal pocket door systems, our current pre-assembled set and our all new self-assembly kit system. They allow doors to disappear effortlessly into your wall, letting you make the most of the space in your room. Pairing this unique system with an LPD Door has endless possibilities to add a feature to your home.

## Gain space with our innovative pocket door systems

Traditional solution

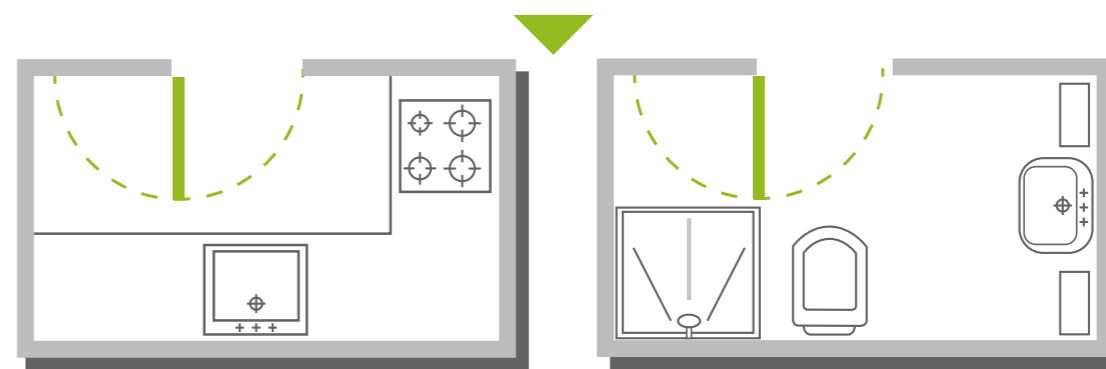

Wasted space!

Innovative Pocket Door solution

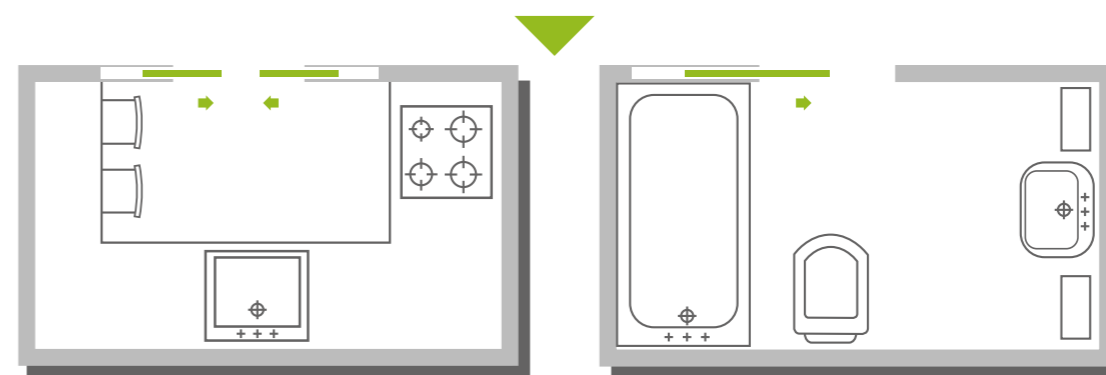

Space gained 2.6m<sup>2</sup>!

White Vancouver shown with Scorpio Matt Black handle

# flusso. Kit



HANGER SYSTEM  
20  
YEAR  
GUARANTEE  
HANGER SYSTEM

Great for smaller projects, this pocket door kit is easy to assemble and typically takes around 30 minutes to install. This contemporary pocket door kit can be combined with the majority of our door range and is the perfect space saving solution!

- Space Saving
- Self-assembly kit
- Suits doors 35 or 40mm thick dependant on set purchased
- Max door weight 120kg per leaf
- 125mm finished wall
- The double kit pocket door solution is created from two singles kits joined together using the junction tongue supplied with each single kit. A double door timber pack is supplied which has a longer crosspiece.

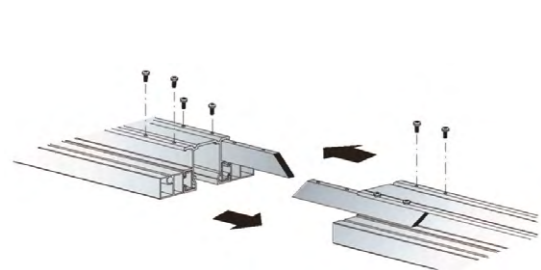

## Single Pocket Door

	Single Door Size				Installation Size Information				
	Imperial		Metric		Clear Opening Size (Walkthrough Area)		Structural Opening Size		Finished Wall Thickness
	Width (LP)	Height (HP)	Width (LP)	Height (HP)	Width (W)	Height (H)	Width (WL)	Height (HI)	(FW)
POCKFLUSTA*	2' (24")	6' 6" (78")	610mm	1981mm	580mm	1970mm	1230mm	2075mm	125mm
	2' 3" (27")		686mm		656mm		1382mm		
	2' 6" (30")		762mm		732mm		1534mm		
POCKFLU33*	2' 9" (33")	6' 6" (78")	838mm	1981mm	808mm	1970mm	1686mm	2075mm	125mm

Code	Single Door Size		Installation Size Information				
	Metric		Clear Opening Size (Walkthrough Area)		Structural Opening Size		Finished Wall Thickness
	Width (LP)	Height (HP)	Width (W)	Height (H)	Width (WL)	Height (HI)	(FW)
POCKFLUMET*	626mm	2040mm	600mm	2030mm	1270mm	2135mm	125mm
	726mm		700mm		1470mm		
	826mm		800mm		1670mm		



Oak Melbourne shown with Scorpio Matt Black handle

This 'cut-away' area shows the hidden internal mechanism of the kit.

## Double Pocket Door

Code	Single Door Size				Installation Size Information				
	Imperial		Metric		Clear Opening Size (Walkthrough Area)		Structural Opening Size		Finished Wall Thickness
	Width (LP)	Height (HP)	Width (LP)	Height (HP)	Width (W)	Height (H)	Width (WL)	Height (HI)	(FW)
POCKFLUDDSTA*	2' (24")	6' 6" (78")	610mm	1981mm	1160mm	1970mm	2405mm	2075mm	125mm
	2' 3" (27")		686mm		1312mm		2709mm		
	2' 6" (30")		762mm		1464mm		3013mm		
POCKFLUDD33*	2' 9" (33")	6' 6" (78")	838mm	1981mm	1616mm	1970mm	3317mm	2075mm	125mm

Code	Single Door Size		Installation Size Information						
	Imperial		Metric		Clear Opening Size (Walkthrough Area)		Structural Opening Size		Finished Wall Thickness
	Width (LP)	Height (HP)	Width (LP)	Height (HP)	Width (W)	Height (H)	Width (WL)	Height (HI)	(FW)
POCKFLUDDMET*	N/A	N/A	626mm	2040mm	1200mm	2030mm	2485mm	2135mm	125mm
	N/A		726mm		1400mm		2885mm		
	N/A		826mm		1600mm		3285mm		

# flusso. Pre-Assembled Set

Convenient, stylish, and ultra-modern, the Flusso pre-assembled pocket door sets can be fully installed within 15 minutes. Designed to work in partition walls, the pre-assembled pocket door set is great for large scale construction projects.



## Easy 5 Step Installation Process

1. Insert aluminium track
2. Attach jamb and space bars
3. Fix to studwork
4. Apply plasterboard and plaster
5. Insert door

 **Jamb Kit Included**  
Available in Unfinished Oak

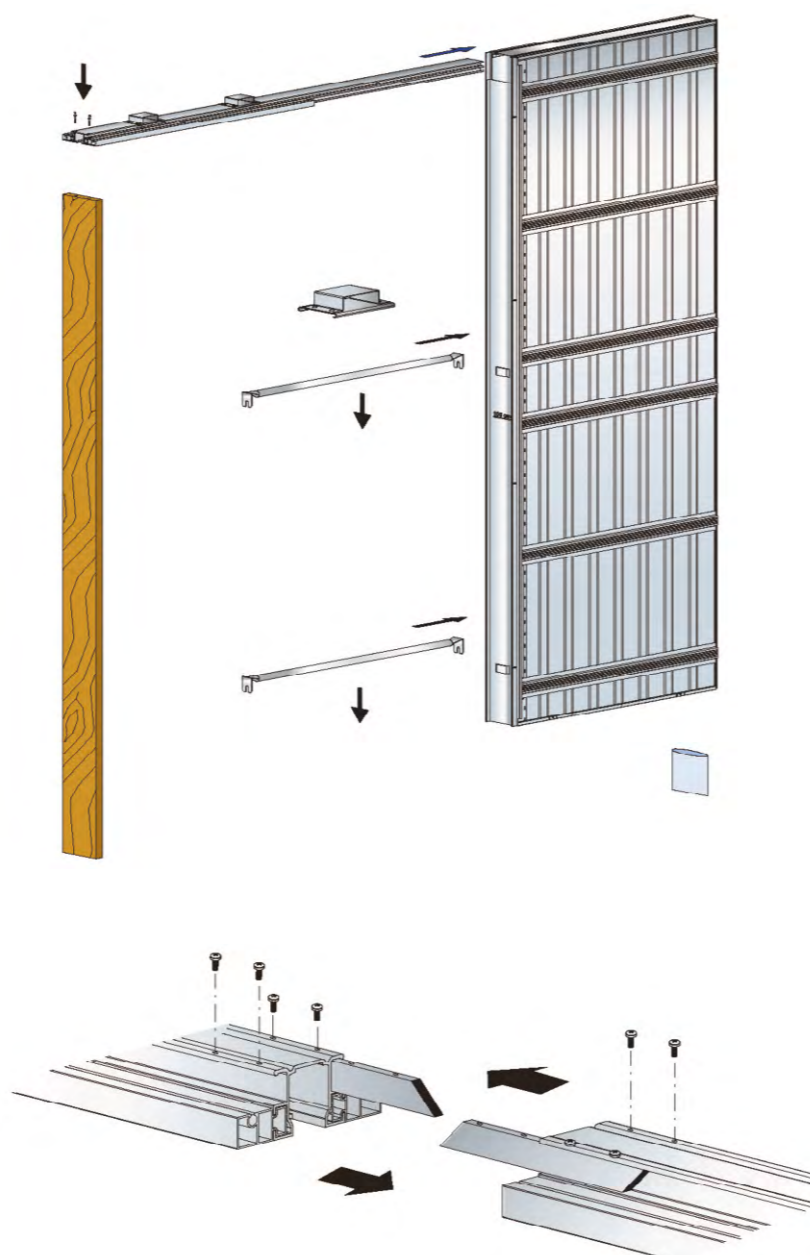

## Available for Single or Double Doors

Time Saving Pre-assembled Pocket

- Space Saving
- Simple Installation
- Suits doors 35 or 40mm thick dependant on set purchased
- Max door weight 120kg per leaf
- Endpost, crosspieces, cassette edge covers, door brushes and seals supplied as standard
- 125mm finished wall

## Single Pocket Door

Code	Single Door Size				Installation Size Information						
	Imperial		Metric		Clear Opening Size (Walkthrough Area)		Cassette	Structural Opening Size		Finished Wall / Internal Space	
	Width (LP)	Height (HP)	Width (LP)	Height (HP)	Width (L)	Height (H)	(C)	Width (IL)	Height (IH)	(FW)	(IS)
POCKSD27*	2' 3" (27")	6' 6" (78")	686mm	1981mm	656mm	1970mm	700	1466mm	2080mm	125mm	70mm
POCKSD30*	2' 6" (30")		762mm		732mm		750	1592mm			
POCKSD33*	2' 9" (33")		838mm		808mm		900	1818mm			
POCKSD726*	N/A	N/A	726mm	2040mm	700mm	2030mm	700	1510mm	2140mm		
POCKSD826*			826mm		800mm		800	1710mm			

## Double Pocket Door

Code	Single Door Size				Installation Size Information						
	Imperial		Metric		Clear Opening Size (Walkthrough Area)		Cassette	Structural Opening Size		Finished Wall / Internal Space	
	Width (LP)	Height (HP)	Width (LP)	Height (HP)	Width (L)	Height (H)	(C)	Width (IL)	Height (IH)	(FW)	(IS)
POCKDD27*	2' 3" (27")	6' 6" (78")	686mm	1981mm	1312mm	1970mm	700	2832mm	2080mm	125mm	70mm
POCKDD30*	2' 6" (30")		762mm		1464mm		750	3084mm			
POCKDD33*	2' 9" (33")		838mm		1616mm		900	3536mm			

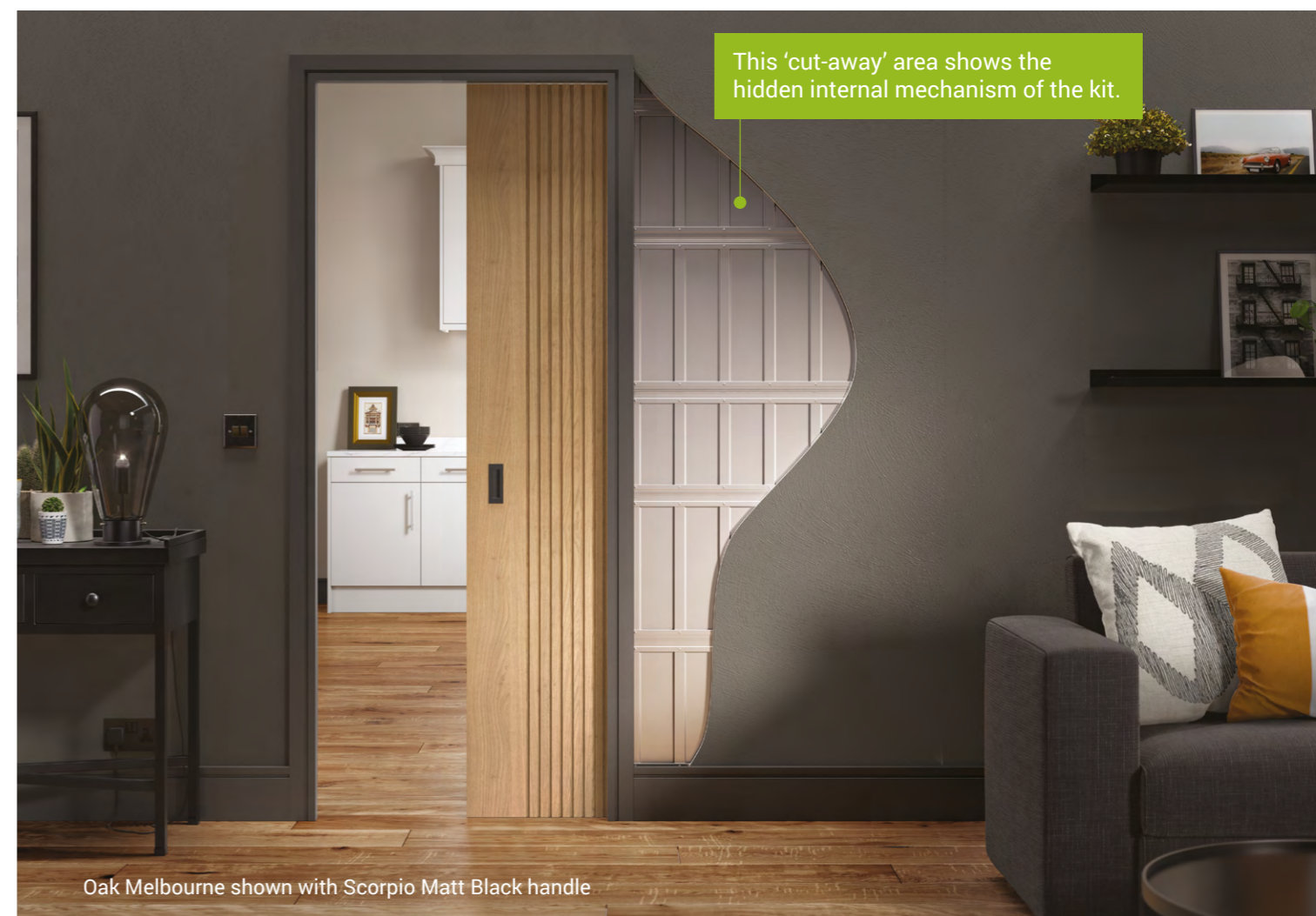

Oak Melbourne shown with Scorpio Matt Black handle

# Choosing the right Pocket Door system

Your requirements will help you decide the correct pocket door system. See below to discover the advantages and benefits of each.

## flusso. Kit\*

The perfect solution for when there is not much space available in your home. Great for making your room styles more flexible resulting in a brighter space. Our Flusso Kits are a practical system designed to work in partition walls. Guaranteed to add effortless style. This kit is compatible with the majority of LPD doors.

- Ideal for small projects such as home renovations
- Self-assembly kit
- 30 minute installation time
- Available for wood and glass doors\*
- Suits doors 35 or 40mm thick dependant on set purchased
- Maximum door weight 120kg per leaf
- 7 pieces in 1 kit to assemble a unit
- Drywall screws included
- Compatible pocket door hardware available
- 125mm finished wall
- Two single kits can be joined together to create a double pocket door, please see more info on page 4

Cost effective solution

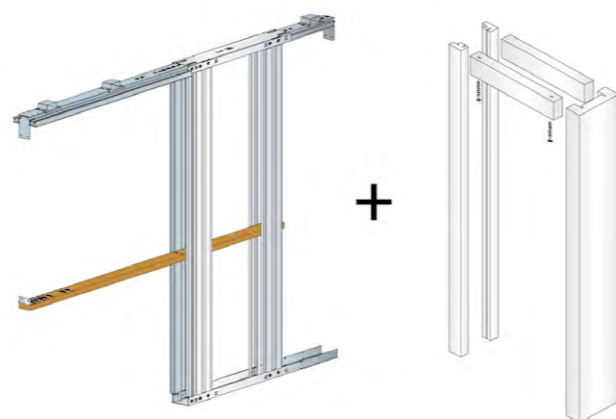

Oak Melbourne shown with Scorpio Matt Black handle

\*Please note: Doors are sold separately. Please check with LPD for what doors can be used with this kit.

## flusso. Pre-Assembled Set\*

A neat and contemporary solution, pocket door systems are ideal for anywhere you don't want a door encroaching into the room. Make the most of your internal space! Our Flusso Pre-assembled Set is a convenient system which contains a cassette like structure for ease of installation. This set will work with the majority of LPD doors.

Available for Single or Double Doors

- Can be used for large scale construction projects or home renovations
- Rapid installation time, completed within 15 minutes
- 125mm finished wall
- Available for wood and glass doors\*
- Suits doors 35 or 40mm thick dependant on set purchased
- Maximum door weight 120kg per leaf
- Sides of the metal box are made using single corrugated steel sheets giving the structure extra rigidity
- No frame deflection
- 60 screws included for precise fitting
- Compatible pocket door hardware available



Oak Melbourne shown with Scorpio Matt Black handle

\*Please note: Doors are sold separately. Please check with LPD for what doors can be used with this set.

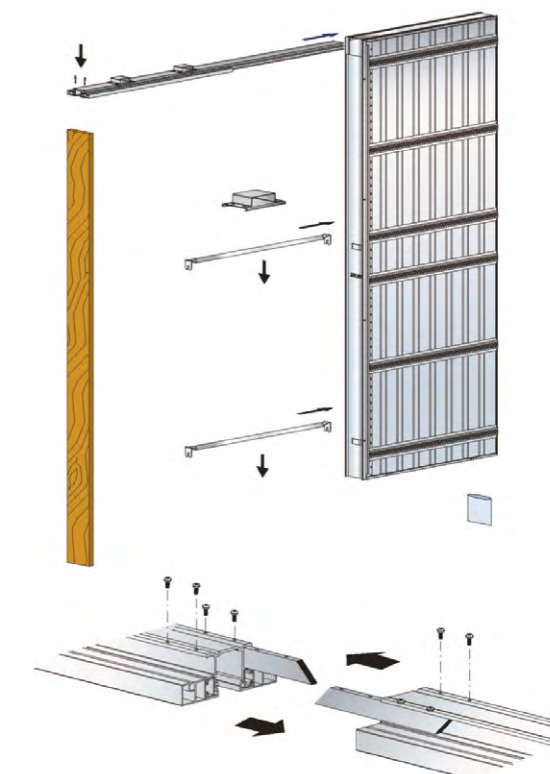

# Pocket Door Handles

Adding the finishing touches to your pocket door is what will make the final impression to your interior. Door accessories are as much significant as the door itself and will transform the look of your pocket door.

## Pisces (finger pull)

Finish Satin Chrome  
Size 30 dia x 24d mm  
Code HARDPOCKPISSC



## Pisces (finger pull)

Finish Matt Black  
Size 30 dia x 24d mm  
Code HARDPOCKPISMB

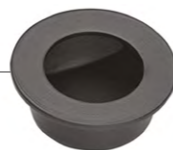

## Virgo

Finish Satin Chrome  
Size 65 dia x 24d mm  
Code HARDPOCKVIRSC



## Virgo

Finish Matt Black  
Size 65 dia x 24d mm  
Code HARDPOCKVIRMB

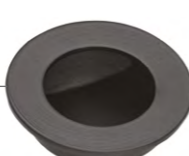

## Scorpio

Finish Satin Chrome  
Size 50w x 120h x 13d mm  
Code HARDPOCKSCOSC



## Scorpio

Finish Matt Black  
Size 50w x 120h x 13d mm  
Code HARDPOCKSCOMB



## Aries

Finish Satin Chrome  
Size 55w x 70h x 62d mm  
Code HARDPOCKARISC



## Aries

Finish Matt Black  
Size 55w x 70h x 62d mm  
Code HARDPOCKARIMB



## Gemini

Finish Satin Chrome  
Size 37w x 180h x 32d mm  
Code HARDPOCKGEMSC



## Gemini

Finish Matt Black  
Size 37w x 180h x 32d mm  
Code HARDPOCKGEMMB



# Accessories and Features

Available for purchase separately



**Slow – Damper Unit**  
Max Door Weight 60kg  
Pre-assembled Set Damper Code DAMPER  
Kit Damper Code POCKFLUDAM

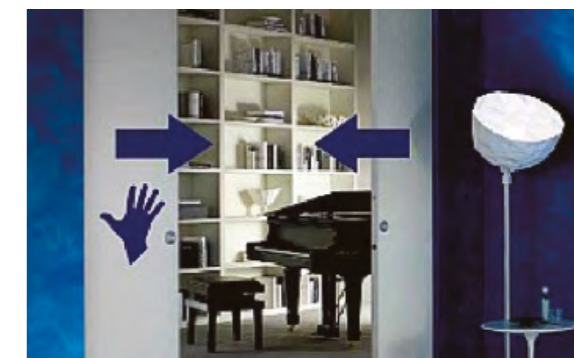

**Double Simultaneous Opening & Closing System**  
Max Door Weight 35kg  
Door Sizes Imperial/Metric  
Please note, this can only be used on the Flusso Pre-assembled Set  
78" x 30" Code POCKDSOCS30  
78" x 33" Code POCKDSOCS33



White Vancouver shown with Scorpio Matt Black handle



**Lpd**  
DOORS

Leeds Plywood & Doors Ltd  
Midland Road

Leeds  
LS10 2RJ

**Sales Line** 0113 271 5151

**Fax** 0113 277 2728

**Email** [sales@lpddoors.co.uk](mailto:sales@lpddoors.co.uk)

**Web** [www.lpddoors.co.uk](http://www.lpddoors.co.uk)